

LED FLOOD LIGHTS LFL-01-LEDP SERIES



TYPE

SPECIFICATIONS

CONSTRUCTION: Extruded aluminum floodlight with cast aluminum adjustable swivel. Heavy-duty stamped aluminum Hood Extension available (add -HE to part number)

LENS: High impact clear acrylic

REFLECTOR: Highly polished specular aluminum

LIGHT SOURCE: 12v, 8w integrated LED flat panel, warm white 3000K

LIFETIME RATING: 50,000 hours

SOCKET: None

12V INTERNAL DRIVER: 8w output, 12v AC input. Voltage range of 9 to 18 volts with optimum operating range of 10 to 15 volts for consistent performance and brightness. For use with magnetic transformers only.

120V INTERNAL DRIVER: 8w output, 120v 20/60Hz input. 240v/277v internal drivers also available

WIRING 12v: Black 3 foot 18/2 zip cord from base of fixture (12v only)
For 25 foot 16/2 fixture lead wire add -25F to catalog number.

WIRING 120v: Standard 120v Black, White and Ground 9" lead wires

MOUNTING 12v: FA-03 black 9" ABS stake, tapped 1/2" NPS

MOUNTING 120v: None supplied. See Mounting Accessories below for options

FINISH: Black texture polyester powder coat. Optional finishes available

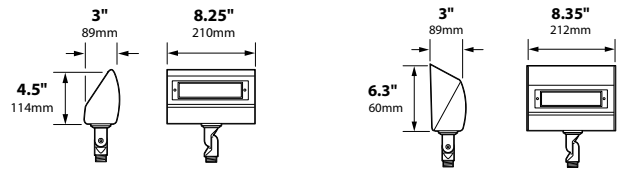

LFL-01-LEDP812V
LFL-01-LEDP8120V

LFL-01-HELEDP812V
LFL-01-HELEDP8120V

ORDERING INFORMATION

CATALOG NO.	DESCRIPTION	LAMP	SHIP WEIGHT
LFL-01-LEDP812VBTL	Aluminum Floodlight	8w, 3000K 12v LED Panel	2.0 lbs.
LFL-01-HELEDP812VBTL	Aluminum Floodlight, hood extension	8w, 3000K 12v LED Panel	2.0 lbs.
LFL-01-LEDP8120VBTL	Aluminum Floodlight	8w, 3000K 120v LED Panel	2.0 lbs.
LFL-01-HELEDP8120VBTL	Aluminum Floodlight, hood extension	8w, 3000K 120v LED Panel	2.0 lbs.
LFL-01-LEDP8240VBTL	Aluminum Floodlight	8w, 3000K 120v LED Panel	2.0 lbs.
LFL-01-HELEDP8240VBTL	Aluminum Floodlight, hood extension	8w, 3000K 120v LED Panel	2.0 lbs.
LFL-01-LEDP8277VBTL	Aluminum Floodlight	8w, 3000K 120v LED Panel	2.0 lbs.
LFL-01-HELEDP8277VBTL	Aluminum Floodlight, hood extension	8w, 3000K 120v LED Panel	2.0 lbs.



MOUNTING ACCESSORIES

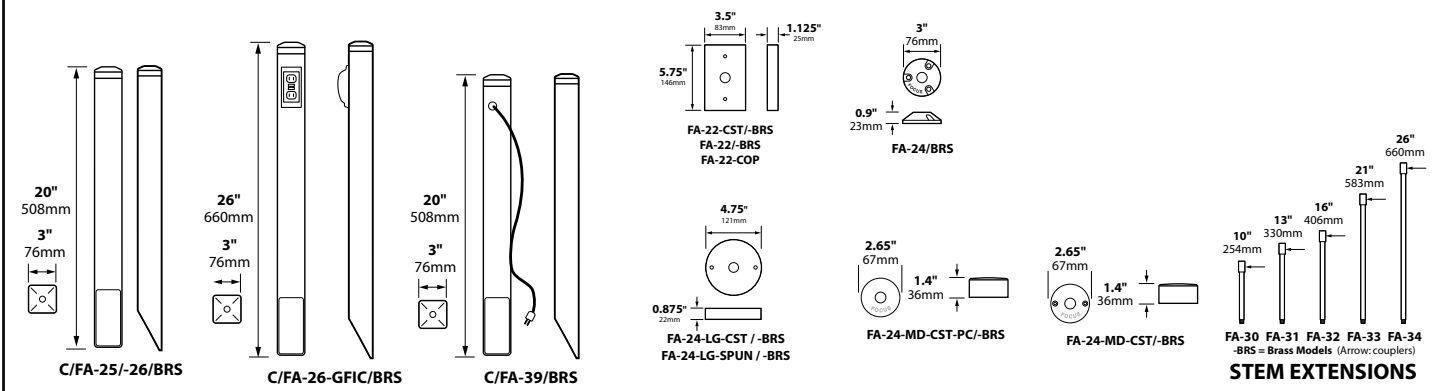

BEAM/GLARE CONTROL ACCESSORIES

-HE Add to catalog number for Hood Extension

JOB INFORMATION

Type: _____ Date: _____

Job Name: _____

Cat. No.: _____

Lamp(s): _____

Specifier: _____

Contractor: _____

Notes: _____



Black Texture (Standard)	Antique Verde	Bronze Texture	Camel	White Texture	Hunter Texture	Rust	Weathered Iron	Weathered Brown	Stucco	Rubbed Verde	Chrome Powder	Terra Cotta	Acid Rust	Acid Verde	Black Acid Treatment
-BLT	-ATV	-BRT	-CAM	-WTX	-HTX	-RST	-WIR	-WBR	-STU	-RBV	-CPR	-TRC	-BAR/CAR	-BAV/CAV	-BAT

LED FLOOD LIGHTS LFL-01-LEDP SERIES



TYPE

LIGHT DISTRIBUTIONS AND PHOTOMETRICS

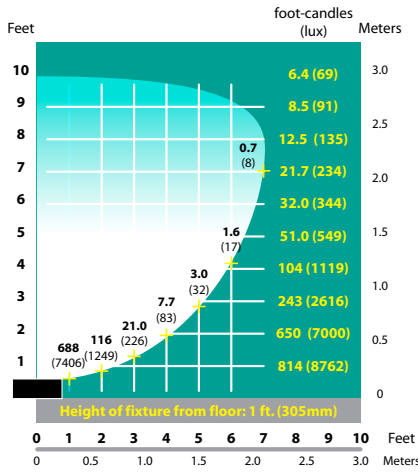

LFL-01-LEDP8 Half Spread Photometrics

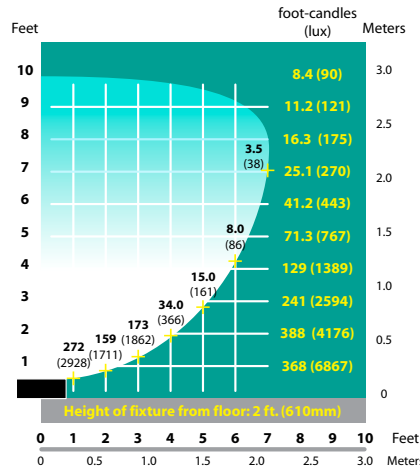

LFL-01-LEDP8 Half Spread Photometrics

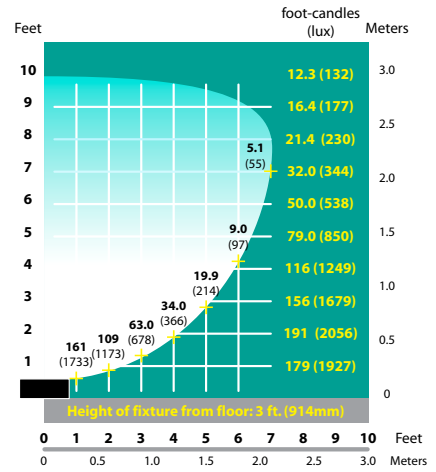

LFL-01-LEDP8 Half Spread Photometrics

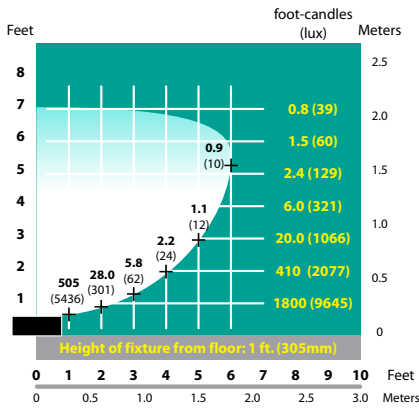

LFL-01HE-LEDP8 Half Spread Photometrics

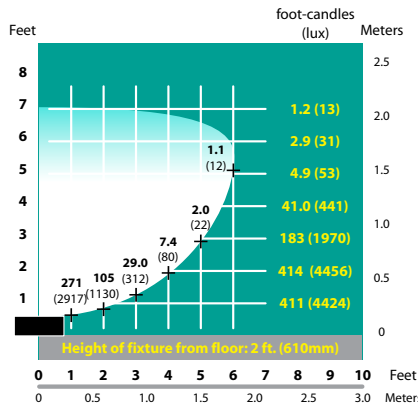

LFL-01HE-LEDP8 Half Spread Photometrics

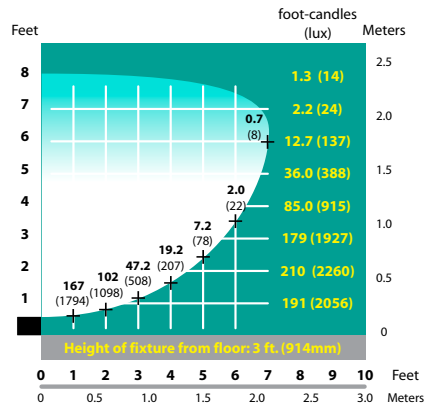

LFL-01HE-LEDP8 Half Spread Photometrics

Black Texture (Standard)	Antique Verde	Bronze Texture	Camel	White Texture	Hunter Texture	Rust	Weathered Iron	Weathered Brown	Stucco	Rubbed Verde	Chrome Powder	Terra Cotta	Acid Rust	Acid Verde	Black Acid Treatment
-BLT	-ATV	-BRT	-CAM	-WTX	-HTX	-RST	-WIR	-WBR	-STU	-RBV	-CPR	-TRC	-BAR/CAR	-BAV/CAV	-BAT