

POLAR 2 NEON, BULK REELS



Instructions for P2-NF-SERIES 120V AC, 60Hz

WARNING: These products may represent a possible shock or fire hazard if improperly installed or attached in any way. Products should be installed in accordance with these instructions, current electrical codes, and/or the current National Electric Code (NEC). Use this product only with its attached plug-in power cord. Any other power cord or feed may damage the fixture. Not intended for hard wire use.

WARNINGS: READ ALL INSTRUCTIONS BEFORE YOU START:

CAUTION - To reduce risk of fire, electric shock, or injury to persons, pay close attention to this manual and stay within its guidelines when using this product. Before use, note that this product requires a 120V AC outlet. Ensure that the voltage of your power supply is compatible!

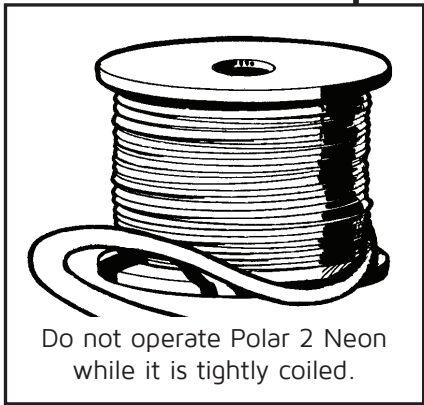

1. Do not cover this product as the covering may cause rope to overheat, melt, or ignite.
2. **Do not operate Polar 2 Neon while it is tightly coiled.**
3. Do not submerge flexible light in liquids, or use the product in the vicinity of standing water or other liquids.
4. Do not route the cord or Polar 2 Neon through walls, ceilings, doors, windows, or any similar part of the building structure.
5. Secure this flexible light using only the mounting clips provided or factory recommended mounting track (sold separately).
6. Do not secure this product or its cord with staples, nails, or like means that may damage the insulation.
7. Do not use if there is any damage to the PVC housing or power cord insulation. Inspect periodically.
8. Do not install on gates or doors, where subject to continuous flexing.
9. Do not install in tanks or enclosures of any kinds.
10. Follow instructions carefully when splicing Polar 2 Neon sections or attaching power cords. Ensure that all connections, including the end cap on the last segment, are properly installed with dielectric grease and shrink tube to preclude the entrance of water (outdoor applications).
11. Risk of fire. Do not replace attachment plug. Discard product if attachment plug is damaged.
12. This product has a polarized plug (one blade is wider than the other) as a feature to reduce the risk of electric shock. This plug will fit in a polarized outlet only one way. If the plug does not fit fully in the outlet, reverse the plug. If it still does not fit, contact a qualified electrician. Never use with an extension cord unless plug can be fully inserted. Do not alter plug.
13. Polar 2 Neon can only be cut at specific intervals as indicated by the cutting marks printed on the side of the PVC housing. Failure to cut at a cut mark, will result in a loss of light. **Before making any cuts or attaching any power cords or jumpers, be sure power source is disconnected! Cutting Polar 2 Neon will void the c/ETL/us Listing!**
14. This product is designed for use by a qualified installer.
15. This product is for decorative use only. Not to be used by children as a toy. Keep out of reach of small children.
16. Do not exceed 150' maximum run distance in any single run.

CAUTION - To reduce the risk of fire, electric shock, or injury to persons:

WARNING: When using outdoor portable lighting products, basic safety precautions should always be followed to reduce the risk of fire, electric shock, and personal injury, including the following:

1. Use dielectric grease and shrink tube at all power connections, including end cap when using outdoors.
2. Use ground fault circuit interrupter (GFCI) protection on the circuit(s) or outlet(s) when using outdoors.
3. Use only UL approved outdoor extension cords, such as type SW, SOW, STW, STOW, SJW, SJOW, SJTW, or SJTOW. This designation is marked on the jacket of the extension cord.

CONNECTING POWER (See Figures 1, 2, 3, and 4)

NOTE: Do not exceed 150' maximum run distance in any single run.

1. Secure attached power cord by tightening threaded collar to Polar 2 Neon. (See Figure 1.)
2. Determine the required length for lighting application. If less than 150 feet is needed, follow the directions on reverse. **NOTE: If cut, the Polar 2 Neon loses the c/ETL/us Listing.**

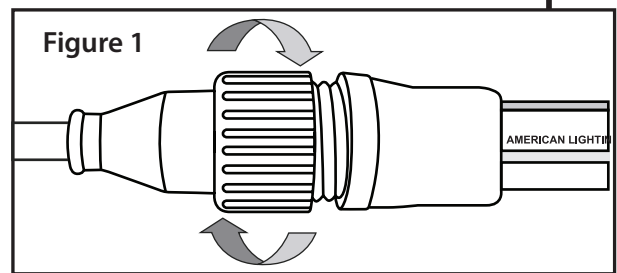

POLAR 2 NEON, BULK REELS



Instructions for P2-NF-SERIES
120V AC, 60Hz

CUTTING POLAR 2 NEON AND CONNECTING POWER CONNECTION KIT (See Figures 2, 3, and 4)

NOTE: Do not exceed 150' maximum run distance in any single run.

3. Cut the Polar 2 Neon squarely at the nearest cut mark using a sharp rope light cutting tool or shears. NOTE: Polar 2 Neon is wired in parallel with 18" cutting increments. Cutting anywhere other than the end/beginning of a cutting increment will damage an LED and/or internal wiring. (See Figure 2)
4. Holding the smooth pins of the power pin with a pair of pliers, line up the barbed pins with the two wires of the flexible light. Push barbed pins into Polar 2 Neon until flush, being sure to make solid contact with the flexible light's internal wires. (See Figure 3).
5. Slide the shrink tube over the assembly and onto the Polar 2 Neon.
6. Push the power cord sheath onto the assembly until fully seated.
7. Slide the heat shrink tube over the power cord sheath so that it is centered over the junction of the Polar 2 Neon and the power cord sheath. (See Figure 4).
8. When using splice kits and/or jumpers, follow steps 1-6 above, making connections in a similar manner.
9. Attach end cap to other end of flexible light to cover exposed dead end.

Figure 2

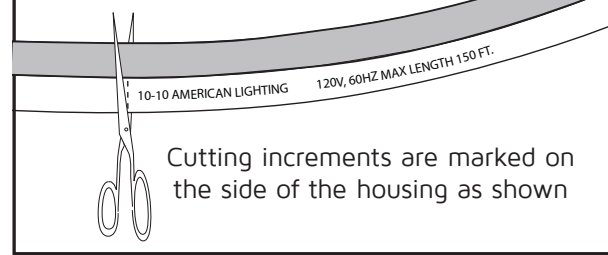

Cutting increments are marked on the side of the housing as shown

Figure 3

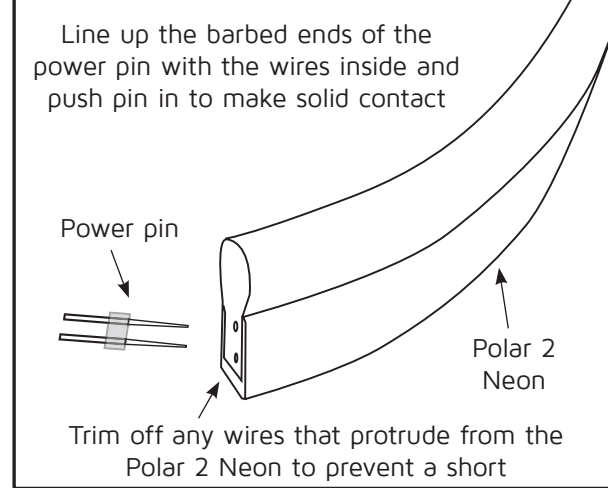

Line up the barbed ends of the power pin with the wires inside and push pin in to make solid contact

Trim off any wires that protrude from the Polar 2 Neon to prevent a short

Figure 4

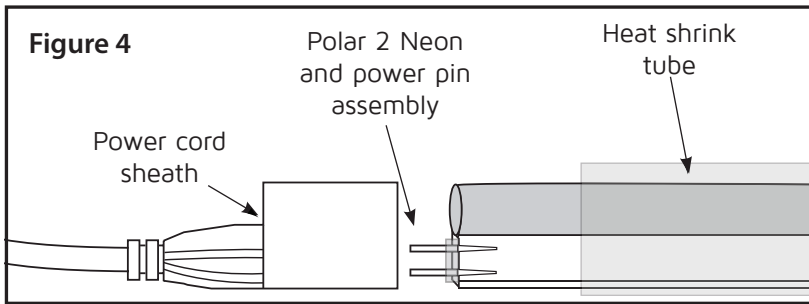

Mounting:

1. Make mounting clips using cut pieces of track (P2-NF-CLIP, sold separately) or for straight line applications, use P2-NF-TRACK-4 mounting track; or use a combination of methods. P2-NF-CHAN aluminum channel is also available (sold separately).
2. Make sure that the distance between any two parallel runs of lighting are at least 1/2" apart.
3. Gently press flexible light into track or clips so that it snaps into place.

DO NOT TWIST, HANG VERTICALLY, OR SUSPEND UNSUPPORTED IN THE MIDDLE:

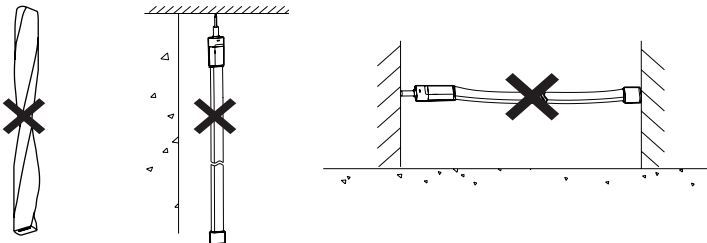

PROP 65 WARNING:

Handling the coated electrical wires of this product exposes you to lead, a chemical known to the State of California to cause cancer, birth defects, and other reproductive harm. Wash hands after use.

TO REPLACE FUSE (SEE FIGURE 5):

This plug contains an electrical fuse as a safety feature.

1. Disconnect power before replacing the fuse.
2. Grasp plug and remove from the receptacle or other outlet device.
3. Do not unplug by pulling on the cord.
4. Slide open the fuse access cover (See Drawing).
5. Remove old fuse carefully.
6. Never attempt to replace the fuse with a higher wattage fuse. Use only 8 Amp 125 Volt fuse. Failure to do so may be a fire hazard. (One spare included.)
7. Set new fuse in holder and close fuse access cover.

Figure 5

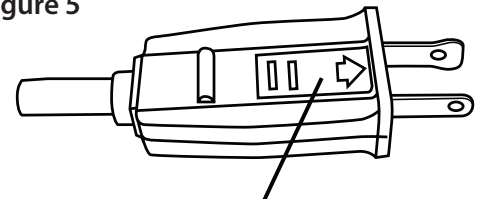

Fuse is inside plug. Slide open fuse access cover as shown.