

SPECIFICATIONS

CONSTRUCTION: Extruded aluminum floodlight with 2 heavy duty cast aluminum adjustable swivels. Stamped aluminum Hood Extension available (add -HE to part number)

LENS: High impact clear acrylic

REFLECTOR: Highly polished specular aluminum

BALLAST: 120v type 1 outdoor high frequency electronic (FFL-24 & FFL-39 only)

120v - 277v Universal Multi Voltage input available, add -MV to catalog number

NOTE: FFL-54 only available in -MV

LAMP SUPPLIED:

FFL-24: 24 watt T5HO tube, 3000K

FFL-39: 39 watt T5HO tube, 3000K

FFL-54: 54 watt T5HO tube, 3000K

LAMP OPTIONS: 3500K, 4100K

SOCKET: G5 2-pin

WIRING: Standard 120 volt Black, White and Ground

MOUNTING: None supplied. See Mounting Accessories below for options

FINISH: Black Texture polyester powder coat. Optional finishes available

NOTE: 2 lamp models available. Consult factory for details



FFL-24-T5HO
mounted on
FA-26-BLT



FFL-39-T5HO
mounted on
FA-26-BLT



FFL-54-T5HO
mounted on
FA-26-BLT

ORDERING INFORMATION

CATALOG NO.	DESCRIPTION	LAMP	SHIP WEIGHT
FFL-24-T5HO30K-BLT	Aluminum T5HO Floodlight	24w, T5HO 3000K	4.0 lbs.
FFL-24-T5HO35K-BLT	Aluminum T5HO Floodlight	24w, T5HO 3500K	4.0 lbs.
FFL-24-T5HO41K-BLT	Aluminum T5HO Floodlight	24w, T5HO 4100K	4.0 lbs.
FFL-39-T5HO30K-BLT	Aluminum T5HO Floodlight	39w, T5HO 3000K	8.0 lbs.
FFL-39-T5HO35K-BLT	Aluminum T5HO Floodlight	39w, T5HO 3500K	8.0 lbs.
FFL-39-T5HO41K-BLT	Aluminum T5HO Floodlight	39w, T5HO 4100K	8.0 lbs.
FFL-54-T5HO30K-MV-BLT	Aluminum T5HO Floodlight	54w, T5HO 3000K	13.0 lbs.
FFL-54-T5HO35K-MV-BLT	Aluminum T5HO Floodlight	54w, T5HO 3500K	13.0 lbs.
FFL-54-T5HO41K-MV-BLT	Aluminum T5HO Floodlight	54w, T5HO 4100K	13.0 lbs.

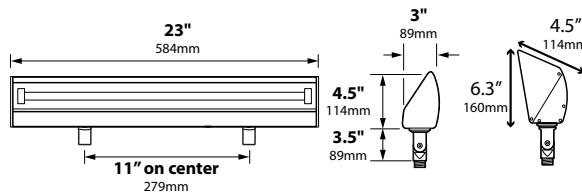

24w T5HO

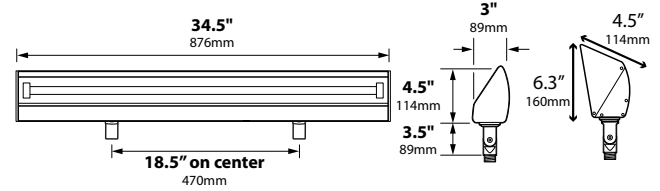

39w T5HO

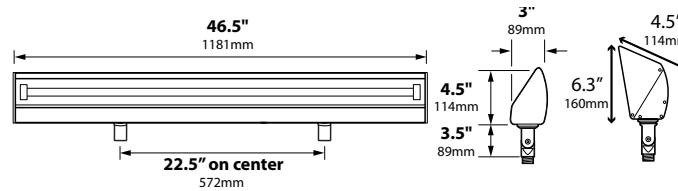

54w T5HO



BEAM/GLARE CONTROL ACCESSORIES

- FA-06-24** 24" long, 1/4" Mini Hex Cell Louver for FFL-24
- FA-06-35** 35" long, 1/4" Mini Hex Cell Louver for FFL-39
- FA-06-47** 47" long, 1/4" Mini Hex Cell Louver for FFL-54

- FA-69-24** Aluminum Hood Extension for FFL-24
- FA-69-39** Aluminum Hood Extension for FFL-39
- FA-69-54** Aluminum Hood Extension for FFL-54

-HE Add to catalog number for factory installed Hood Extension

JOB INFORMATION

Type: _____ Date: _____

Job Name: _____

Cat. No.: _____

Lamp(s): _____

Specifier: _____

Contractor: _____

Notes: _____

Black Texture (Standard)	Antique Verde	Bronze Texture	Camel	White Texture	Hunter Texture	Rust	Weathered Iron	Weathered Brown	Stucco	Rubbed Verde	Chrome Powder	Acid Rust	Acid Verde	Black Acid Treatment
-BLT	-ATV	-BRT	-CAM	-WTX	-HTX	-RST	-WIR	-WBR	-STU	-RBV	-CPR	-BAR/CAR	-BAV/CAV	-BAT

MOUNTING ACCESSORIES

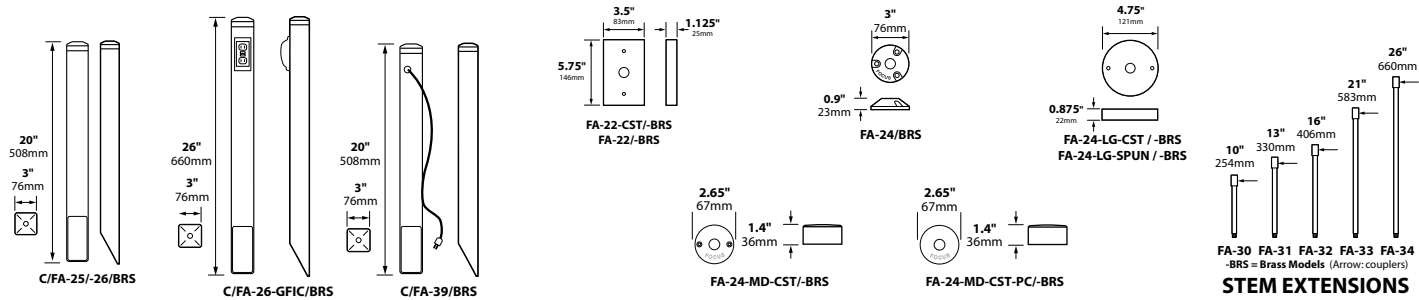

LIGHT DISTRIBUTIONS AND PHOTOMETRICS

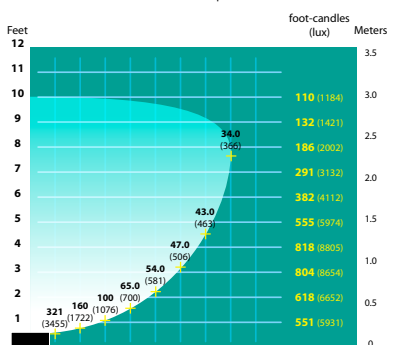
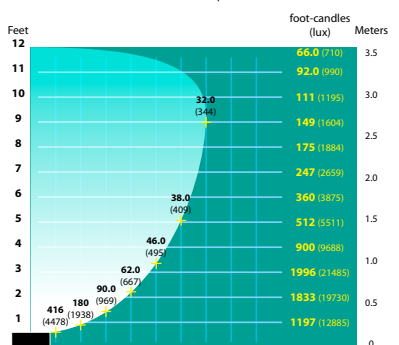
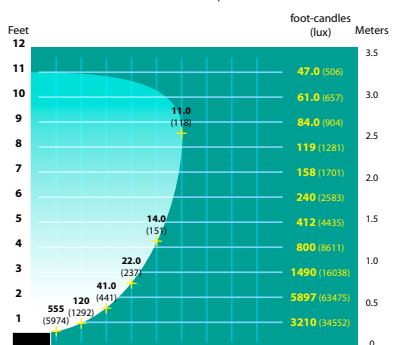
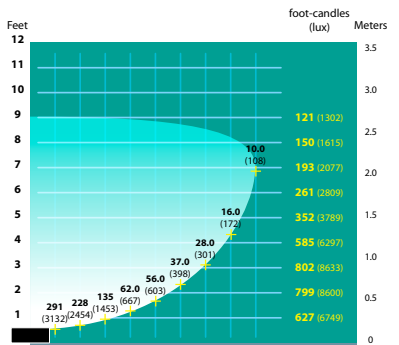
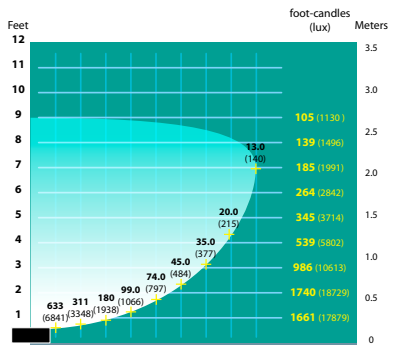
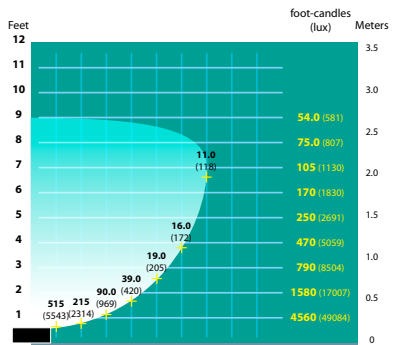
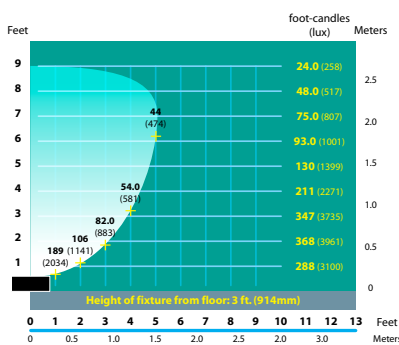
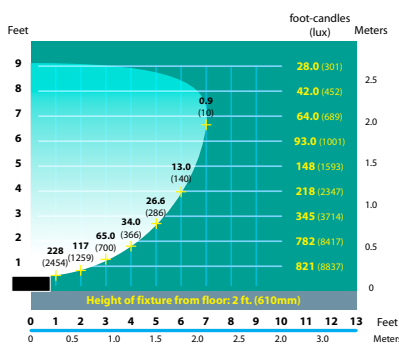
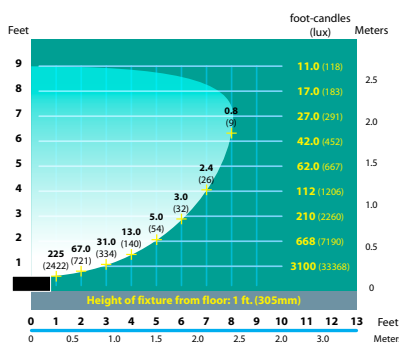

Black Texture (Standard)	Antique Verde	Bronze Texture	Camel	White Texture	Hunter Texture	Rust	Weathered Iron	Weathered Brown	Stucco	Rubbed Verde	Chrome Powder	Acid Rust	Acid Verde	Black Acid Treatment
-BLT	-ATV	-BRT	-CAM	-WTX	-HTX	-RST	-WIR	-WBR	-STU	-RBV	-CPR	-BAR/CAR	-BAV/CAV	-BAT