



landscape • entertainment • architectural • hospitality • illumination

RXD-03TS/04TS DIRECTIONAL LIGHTS



25301 COMMERCENTRE DRIVE • LAKE FOREST, CA 92630 • 949.830.1350 • 888.882.1350 • FAX 949.830.3390



DIRECTIONAL LIGHTS RXD-03-TS & -04-TS



TYPE

SPECIFICATIONS

CONSTRUCTION: Copper tube shield bullet; cast brass adjustable swivel with 240° rotation

LENS: High impact clear tempered convex glass

O-RING: High temperature red silicone

LAMP SUPPLIED:

RXD-03: 20w MR11 FL(FTD) 5000 hours average rating (20w max)

RXD-04: 20w MR8 NFL 2000 hours average rating (20w max)

LAMP OPTIONS:

RXD-03: 20w MR11 ULTRA10,000 hours average rating or

2w ARROW LED MR11 50,000 hours average rating

RXD-04: 20w MR8 NSP 2000 hours average rating

SOCKET: High temperature ceramic G4 bi-pin with 250°C silicone lead wires

WIRING: Black 3 foot 18/2 zip cord from base of fixture (12v only)

For 25 foot 16/2 fixture lead wire add -25F to catalog number.

CONNECTION: FA-05 Quick Connector (not supplied) from fixture to main cable (12/2, 10/2 or 8/2 only)

MOUNTING: FA-03 black 9" ABS stake threaded 1/2" NPS

FINISH: Copper - Unfinished only

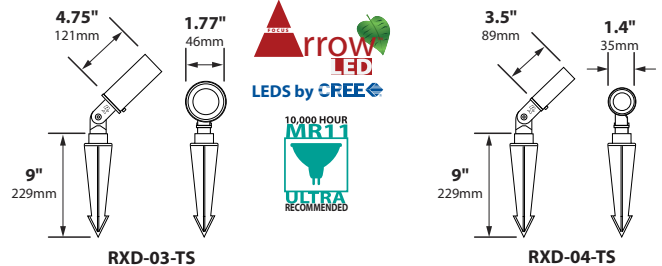

RXD-03-TS

RXD-04-TS

ORDERING INFORMATION

CATALOG NO.	DESCRIPTION	LAMP	SHIP WEIGHT
RXD-03-TS-COP	Copper Tube Shield Bullet	20w MR11 FL(FTD)	2.0 lbs.
RXD-04-TS-COP	Copper Tube Shield Bullet	20w MR8 NFL	2.0 lbs.



RXD-03-TS-COP
shown on FA-24-BRS

RXD-04-TS-COP
shown on FA-24-BRS



IP65

LAMP AND STAKE **INSTALLED** TO SAVE YOU TIME AND MONEY

MOUNTING ACCESSORIES

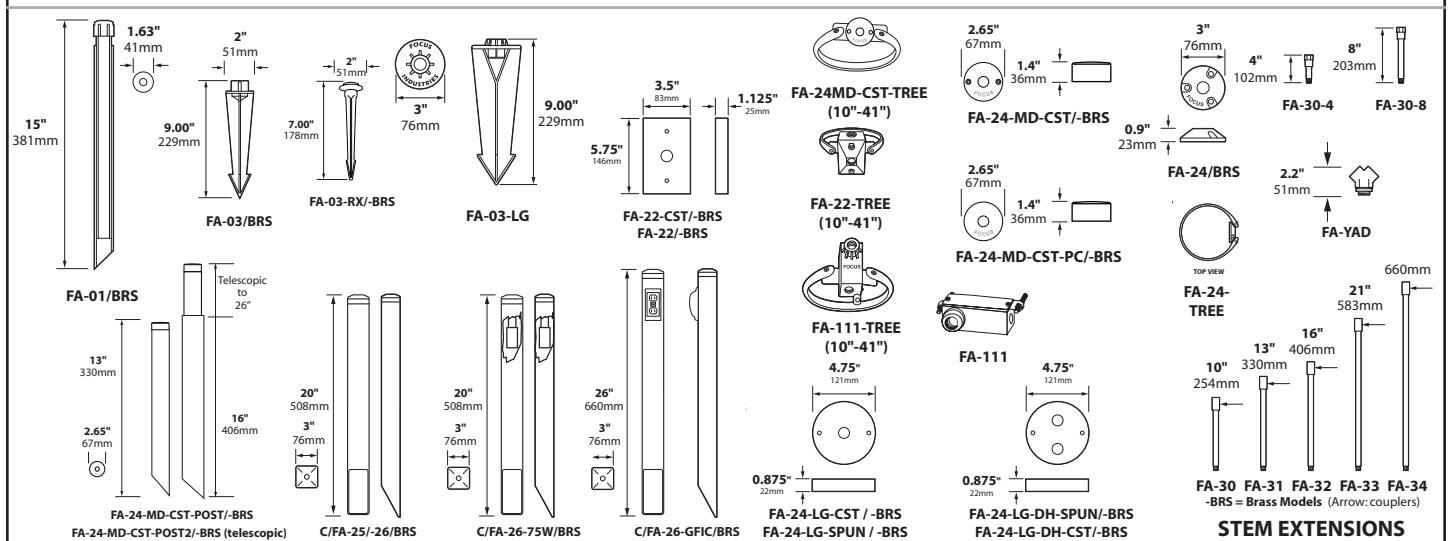

BEAM/GLARE CONTROL ACCESSORIES

- RXD-03**
- FA-08-17 Round 1/4" Hex Cell Louver
 - FA-10-17-BLUE Blue Tempered Glass Lens
 - FA-10-17-GREEN Green Tempered Glass Lens
 - FA-98-17 Linear Spread Tempered Glass Lens
 - FA-104-17 Wide Spread Sandblasted Glass Lens Softener
- RXD-04**
- FA-08-23 Round 1/4" Hex Cell Louver
 - FA-11-23-BLUE Blue Tempered Glass Lens
 - FA-11-23-GREEN Green Tempered Glass Lens
 - FA-98-23 Linear Spread Tempered Glass Lens
 - FA-104-23 Wide Spread Sandblasted Glass Lens Softener

**MR16 MODELS
AVAILABLE
SEE RXD-02-TS
CUT SHEET**

JOB INFORMATION	
Type:	Date:
Job Name:	
Cat. No.:	
Lamp(s):	
Specifier:	
Contractor:	
Notes:	
FOCUS INDUSTRIES INC.® 25301 COMMERCIAL DRIVE LAKE FOREST, CA 92630	
www.focusindustries.com sales@focusindustries.com (949) 830-1350 • FAX (949) 830-3390	



DIRECTIONAL LIGHTS RXD-02-TS SERIES



TYPE

LIGHT DISTRIBUTIONS AND PHOTOMETRICS

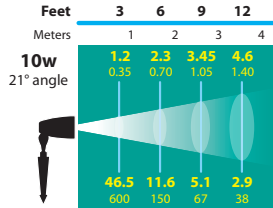

FL-13W-FG

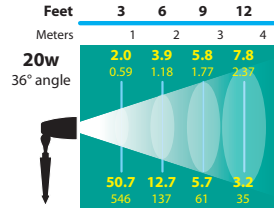

FL-13-BAB-FG

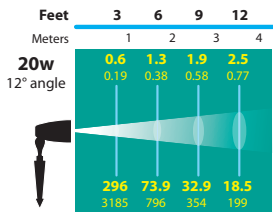

FL-13-ESX-FG

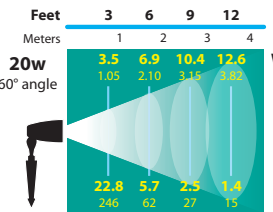

FL-13-VWFL-FG

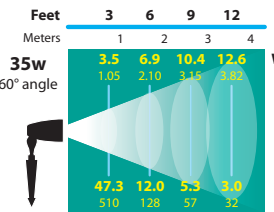

FL-15-FMW-60-FG

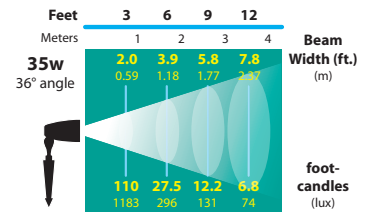

**FL-15-FMW-FG
FL-15-FMW-ULTRA**

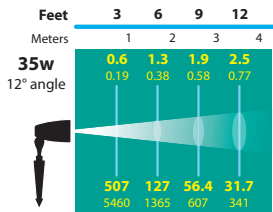

FL-15-FMT-FG

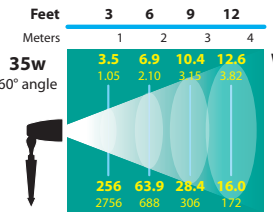

**FL-15-FMV-FG
FL-15-FMV-ULTRA**

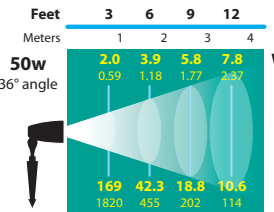

**FL-10-EXN-FG
FL-10-EXN-ULTRA**

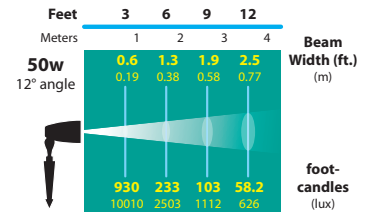

**FL-10-EXT-FG
FL-10-EXT-ULTRA**

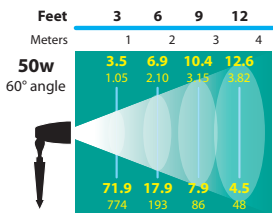

FL-10-VWFL-FG

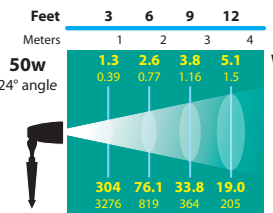

FL-10-EXZ-ULTRA

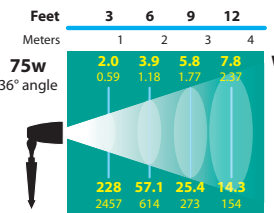

FL-13-EYC-FG

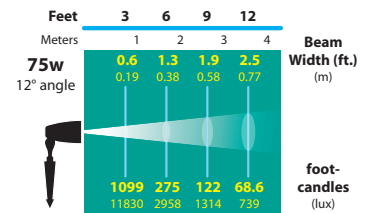

FL-20-EYF-FG

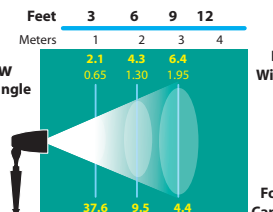

FL-LED-MR16-BAB

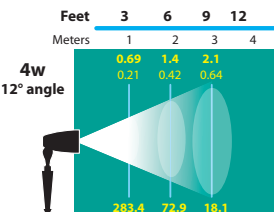

FL-LED-MR16-ESX